

TKO® 115

SINGLE-UNIT BASS AMPLIFIER

O P E R A T I N G G U I D E





Intended to alert the user to the presence of uninsulated “dangerous voltage” within the product’s enclosure that may be of sufficient magnitude to constitute a risk of electric shock to persons.



Intended to alert the user to the presence of important operating and maintenance (servicing) instructions in the literature accompanying the product.

CAUTION Risk of electrical shock — DO NOT OPEN!

CAUTION To reduce the risk of electric shock, do not remove cover. No user serviceable parts inside. Refer servicing to qualified service personnel.

WARNING To prevent electrical shock or fire hazard, do not expose this appliance to rain or moisture. Before using this appliance, read the operating guide for further warnings.



Este símbolo tiene el propósito de alertar al usuario de la presencia de “(voltaje) peligroso” que no tiene aislamiento dentro de la caja del producto que puede tener una magnitud suficiente como para constituir riesgo de corrientazo.



Este símbolo tiene el propósito de alertar al usuario de la presencia de instrucciones importantes sobre la operación y mantenimiento en la literatura que viene con el producto.

PRECAUCION Riesgo de corrientazo — No abra.

PRECAUCION Para disminuir el riesgo de corrientazo, no abra la cubierta. No hay piezas adentro que el usuario pueda reparar. Deje todo mantenimiento a los técnicos calificados.

ADVERTENCIA Para evitar corrientazos o peligro de incendio, no deje expuesto a la lluvia o humedad este aparato. Antes de usar este aparato, lea más advertencias en la guía de operación.



Ce symbole est utilisé pour indiquer à l'utilisateur la présence à l'intérieur de ce produit de tension non isolée dangereuse pouvant être d'intensité suffisante pour constituer un risque de choc électrique.



Ce symbole est utilisé pour indiquer à l'utilisateur qu'il ou qu'elle trouvera d'importantes instructions sur l'utilisation et l'entretien (service) de l'appareil dans la littérature accompagnant le produit.

ATTENTION Risques de choc électrique — NE PAS OUVRIR!

ATTENTION Afin de réduire le risque de choc électrique, ne pas enlever le couvercle. Il ne se trouve à l'intérieur aucune pièce pouvant être réparée par l'utilisateur. Confier l'entretien à un personnel qualifié.

AVERTISSEMENT Afin de prévenir les risques de décharge électrique ou de feu, n'exposez pas cet appareil à la pluie ou à l'humidité. Avant d'utiliser cet appareil, lisez les avertissements supplémentaires situés dans le guide d'utilisation.



Dieses Symbol soll den Anwender vor unisolierten gefährlichen Spannungen innerhalb des Gehäuses warnen, die von Ausreichender Stärke sind, um einen elektrischen Schlag verursachen zu können.



Dieses Symbol soll den Benutzer auf wichtige Instruktionen in der Bedienungsanleitung aufmerksam machen, die Handhabung und Wartung des Produkts betreffen.

VORSICHT Risiko — Elektrischer Schlag! Nicht öffnen!

VORSICHT Um das Risiko eines elektrischen Schlages zu vermeiden, nicht die Abdeckung entfernen. Es befinden sich keine Teile darin, die vom Anwender repariert werden könnten. Reparaturen nur von qualifiziertem Fachpersonal durchführen lassen.

ACHTUNG Um einen elektrischen Schlag oder Feuergefahr zu vermeiden, sollte dieses Gerät nicht dem Regen oder Feuchtigkeit ausgesetzt werden. Vor Inbetriebnahme unbedingt die Bedienungsanleitung lesen.

ENGLISH

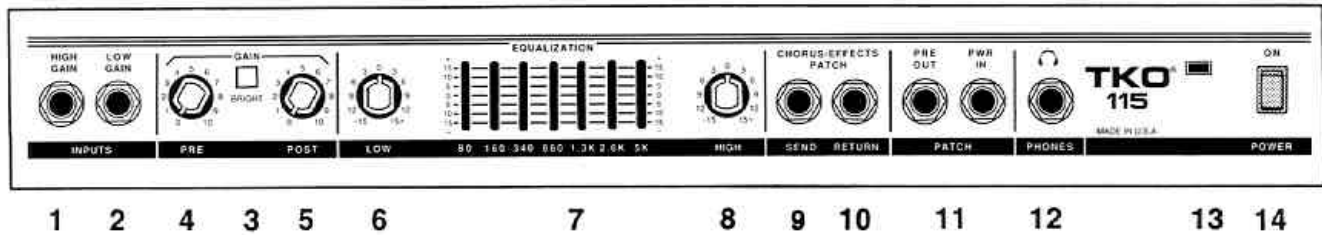

HIGH GAIN INPUT (1)

Used for most electric basses. It is 6 dB louder than the Low Gain Input.

LOW GAIN INPUT (2)

Provided for instruments that have extremely high outputs, which can result in overdriving (distorting) the High Gain input. If both inputs are used simultaneously, the output levels are the same (both are High Gain).

BRIGHT SWITCH (3)

Provides a preset boost (+8 dB) to treble frequencies. To activate, depress the switch to its "in" position.

PRE GAIN (4)

Controls the input gain of the preamplifier.

POST GAIN (5)

Controls the overall volume level of the amplifier. The final level adjustment should be made after the desired sound has been achieved.

LOW (6)

An active tone control (shelving type, ± 15 dB) that varies the low frequency boost or cut.

OPERATION NOTE: Excessive EQ boost, especially of the low frequencies, increases the possibility of speaker damage, and sacrifices valuable headroom.

GRAPHIC EQUALIZER (7)

This seven-band, one octave equalizer provides 15 dB of boost or cut at each center frequency.

HIGH (8)

An active tone control (shelving type, ± 15 dB) that varies the high frequency boost or cut.

CHORUS/EFFECTS SEND (9)

High pass output above 200 Hz for supplying signals to external effects or signal processing equipment.

EFFECTS RETURN (10)

Provided for patching an effects device output back into the mixer. May also be used as an independently variable auxiliary input.

PREAMP OUT/POWER AMP IN (11)

These jacks are provided for in-line patching of effects devices. To patch an effects unit, connect the Preamp Output to the Input of the device. Next, connect the output of the device to the Power Amp Input (high-quality shielded cables must be used for these connections). The Preamp Output can also be used to route the amplified signal to a mixing console, tape recorder, etc. Connect the Preamp Output, using a shielded cable, to an input of the tape recorder, mixer, etc. This patch does not affect the operation of the amplifier.

NOTE: The preamp output level is approximately 1 volt RMS and is of relatively low impedance (600 ohms). Any effects device used in this effects loop must be capable of receiving 1 volt input and providing 1 volt output in order to properly drive the power amp. The Power Amp Input has an internal switch which disconnects the internal preamp.

HEADPHONE JACK (12)

This stereo jack allows signal to flow to both sides of any stereo headset.

POWER LED (13)

Illuminates when AC power is being supplied to the amp.

POWER SWITCH (14)

Depress to "On" position to turn on.

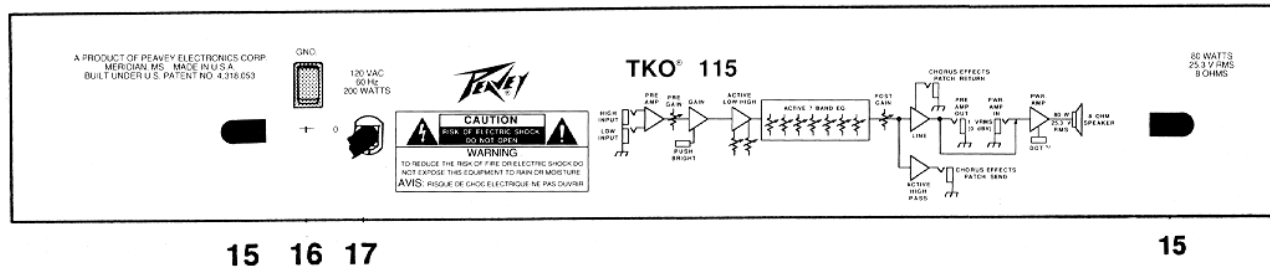

LINE (MAINS) CORD RETAINERS (15)

Allow storage of mains cable for travel.

GROUND SWITCH (16)

Three position rocker-type switch which, in most applications, should be operated in its center or zero position. There may be some situations when audible hum and/or noise will come from the loudspeaker. If this situation arises, position the ground switch to either positive or negative (+ or -) or until the noise is minimized.

NOTE: Should the noise problem continue, consult your Authorized Peavey Dealer, the Peavey Factory, or a qualified service technician. THE GROUND SWITCH IS NOT FUNCTIONAL ON 220/240 VOLT MODELS.

LINE CORD (120V PRODUCTS ONLY) (17)

For your safety, we have incorporated a 3-wire line (mains) cable with proper grounding facilities. It is not advisable to remove the ground pin under any circumstances. If it is necessary to use the equipment without proper grounding facilities, suitable grounding adaptors should be used. Less noise and greatly reduced shock hazard exists when the unit is operated with the proper grounded receptacles.

TONE SETTINGS

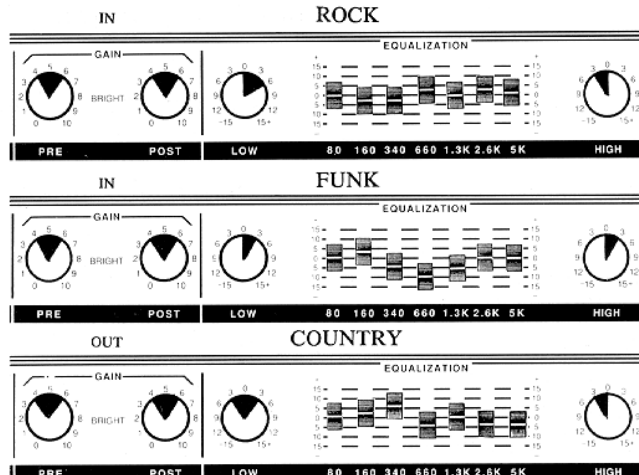

Tone settings given are general and will vary according to type of guitar, type and gauges of strings, type of pickup and even type of pick. Personal taste, playing style, and type of music greatly contribute to desired tonality.

SPECIFICATIONS

POWER AMPLIFIER SECTION

Rated Power & Load:

75W RMS into 8 ohms with
DDT™ compression

Power @ Clipping: (Typically)

(1 kHz, 120 VAC line)
76 W RMS into 8 ohms @
1% THD
84 W RMS into 8 ohms @ 5%

Frequency Response:

+0, -2 dB, 20 Hz to 20 kHz
@ 70 W RMS into 8 ohms

Total Harmonic Distortion:

Less than 0.2%, 100 mW to
70 W RMS, 20 Hz to 10 kHz,
8 ohms, typically below 0.1%

DDT™ Dynamic Range:

Greater than 20 dB

DDT™ Maximum THD:

Below 0.6% THD for 6 dB
overload
Below 1% THD for 16 dB
overload

Hum & Noise:

Greater than 90 dB below rated
power

Power Consumption: (Domestic)

200 watts @ 120 V AC,
50/60 Hz

PREAMP SECTION

The following specs are measured @ 1 kHz
with the Low, High & Graphic EQ @ 0 dB;
Push Bright out (off); and Post Gain @ 10.
Nominal levels are with Pre Gain @ 5;
minimum levels are with Pre Gain @ 10.

Preamp High Gain Input:

Impedance: High Z, 220K ohms
Nominal Input Level: -20 dBV,
100 mV RMS
Minimum Input Level: -40 dBV,
10 mV RMS
Maximum Input Level: +10 dBV,
3 V RMS

Preamp Low Gain Input:

Impedance: High Z, 44K ohms
Nominal Input Level: -14 dBV,
200 mV RMS
Minimum Input Level: -34 dBV,
20 mV RMS
Maximum Input Level: +16 dBV,
6 V RMS

Effects Patch Send: (High Pass Output)

Load Impedance: 10 K ohms or
greater
Nominal Output Level: -12 dBV,
0.25 V RMS
Maximum Output Level:
+8 dBV, 2.5 V RMS

Effects Patch Return:

Impedance: High Z, 22K ohms
Designed Input Level: -12 dBV,
0.25 V RMS
(Remixes with Main Full Range
Signal; designed for Low Level
chorus or flange)

Preamp Output:

Load Impedance: 1K ohms or
greater
Nominal Output Level: 0 dBV,
1 V RMS
(At the DDT limit of 75W RMS
Output)
Maximum Output Level:
+18 dBV, 8 V RMS

Power Amp Input:

Impedance: High Z, 22K ohms
Designed Input Level: 0 dBV,
1 V RMS
(Switching jack providing
preamp output to power amp in-
put connection when not used)

Headphone Output:

Load Impedance: 4 ohms or
greater
Nominal power output: 100 mW
into 4 ohms
(Stereo jack, monaural signal,
disconnects internal speaker
when phone plug is inserted)

System Hum & Noise @ Nominal Input Level:

(20 Hz to 20 kHz unweighted)
85 dB below rated power

Equalization:

Low & High: ±15 dB @ 80 Hz
& 8 kHz, shelving
7 Band Graphic: ±15 dB @ 80,
160, 340, 660, 1.3K, 2.6K, 5K,
PEAK/NOTCH
Push Bright: +8 dB @ 5 kHz

BLOCK DIAGRAM

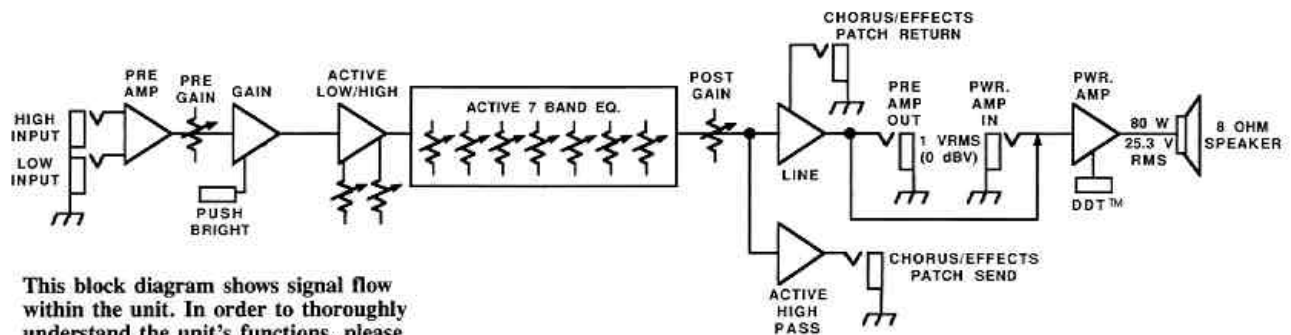

This block diagram shows signal flow
within the unit. In order to thoroughly
understand the unit's functions, please
study the diagram carefully.

Consulte los diagramas del panel delantero en la sección de inglés de este manual.

HIGH GAIN INPUT (Entrada de alta ganancia) (1)

Se usa para la mayoría de los bajos eléctricos. Tiene 6 dB más volumen que la entrada de baja ganancia.

LOW GAIN INPUT (Entrada de baja ganancia) (2)

Se suministra para instrumentos que tienen una salida extremadamente alta, la cual puede causar la sobrecarga (distorsión) de la entrada de alta ganancia. Si se usan ambas entradas simultáneamente, el nivel de salida es el mismo (ambos son de alta ganancia).

BRIGHT SWITCH (Interruptor de brillo) (3)

Proporciona un impulso de +8 dB a las frecuencias agudas. Para activar empuje el interruptor hacia dentro.

PRE GAIN (Ganancia previa) (4)

Controla la ganancia de entrada del preamplificador.

POST GAIN (Control de ganancia posterior al preamplificador) (5)

Controla el nivel global de volumen del amplificador. El ajuste final de nivel debe hacerse una vez que se haya conseguido el sonido deseado.

LOW (Bajo) (6)

Un control de tono activo (tipo "repisa" ± 15 dB) que varía la baja frecuencia, la aumenta o la disminuye.

OPERATION NOTE: (Nota de operación:)

El exceso de ecualización, especialmente en las frecuencias graves, aumenta la posibilidad de dañar los altavoces y también desperdicia valiosa gama dinámica.

GRAPHIC EQUALIZER (Ecuador gráfico) (7)

Este ecualizador de 7 bandas y una octava proporciona 15 dB de impulso o reducción a cada frecuencia media.

HIGH (Control de frecuencias agudas) (8)

Un control de tono activo (tipo "repisa" ± 15 dB) que varía el impulso o la reducción de las frecuencias agudas.

CHORUS/EFFECTS SEND (Envío de coro/efectos) (9)

Salida de banda alta sobre 200 Hz para proporcionar señales a efectos externos o equipos procesadores de señal.

EFFECTS RETURN (Retorno de efectos) (10)

Se suministra para hacer puente entre la salida de un efecto hacia el mezclador. Se puede usar también como una entrada auxiliar independientemente variable.

PREAMP OUT/POWER AMP IN

(Salida del preamplificador/Entrada del amplificador de potencia) (11)

Se suministran estos enchufes hembras para conectar aparatos de efectos en línea. Para conectar un aparato de efectos, conecte la salida del preamplificador a la entrada del aparato, después conecte la salida del aparato a la entrada del amplificador de potencia. (Para este tipo de conexión debe usar cables blindados de buena calidad.) La salida del preamplificador también se puede usar para mandar la señal a nivel de línea a una consola de mezcla, grabadora, etc. Esta conexión no afecta la función del amplificador.

NOTA: El nivel de salida del preamplificador es aproximadamente 1 voltio "RMS" y es de relativamente baja impedancia (600 ohms). Cualquier aparato de efectos que se use en este lazo de efectos debe ser capaz de recibir 1 voltio de entrada y proveer 1 voltio de salida para impulsar correctamente el amplificador de potencia. La entrada del amplificador de potencia tiene un interruptor interno que desconecta el preamplificador interno.

HEADPHONE JACK (Enchufe hembra de audífonos) (12)

Este enchufe hembra estereofónico permite llegar a las señales a ambos lados de cualquier audífono estereofónico.

POWER LED (LED indicador de corriente) (13)

Se ilumina cuando el amplificador recibe corriente alterna.

POWER SWITCH (Interruptor de Corriente) (14)

Empuje éste interruptor para encender el aparato.

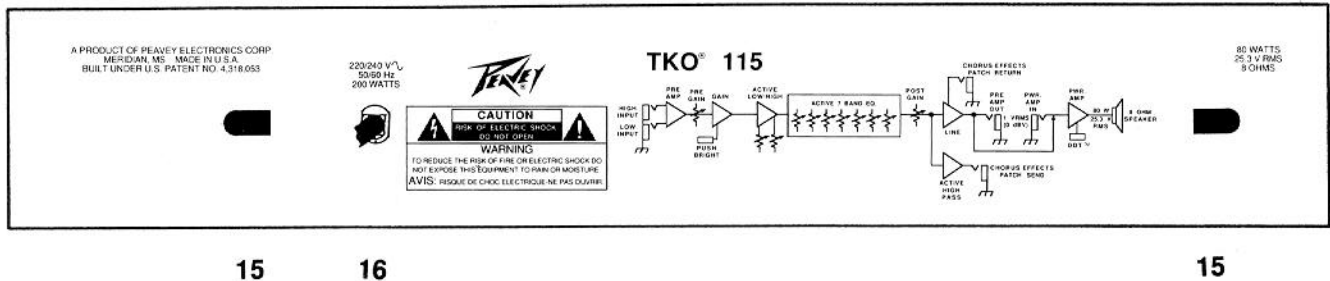

LINE (MAINS) CORD RETAINERS. (Guardacable para cables principales) (15)

Permite almacenar los cables principales para traslado.

GROUND SWITCH (Interruptor de tierra) (16)

Un interruptor tipo balancín de tres posiciones que, en la mayoría de las aplicaciones, debe ser operado en su posición del centro o cero (0). Puede haber situaciones cuando un zumbido audible salga del altavoz. Si esta situación ocurre, ajuste la posición del interruptor de tierra a positivo o negativo (+ o -) o hasta que el ruido disminuya.

NOTA: Si el problema de ruido continúa, consulte su representante autorizado de Peavey, la fábrica de Peavey, o un técnico de servicio calificado. EL INTERRUPTOR DE TIERRA NO FUNCIONA EN LOS MODELOS DE 220/240 VOLTIOS.

LINE CORD (120 V PRODUCTS ONLY) (Cable de corriente para 120 v solamente) (17)

Para su protección hemos incorporado un cable de 3 polos con polo a tierra. No es recomendable remover la pata del polo a tierra bajo ninguna circunstancia, se recomienda un adaptador en caso necesario. Esto reducirá ruidos y peligrosos corrientazos.

FRANÇAIS

**Veillez vous référer au “front panel line art”
situé dans la section en langue anglaise de ce manuel.**

HIGH GAIN INPUT (Entrée haut gain) (1)

À utiliser avec la plupart des basses électriques. Elle donne un volume plus élevé de 6 dB que l'entrée “Low Gain”.

LOW GAIN INPUT (Entrée faible Gain) (2)

Cette prise accepte les instruments à très haut niveau de sortie qui causeraient de la saturation (distorsion) sur l'entrée “High Gain”. Si les deux entrées sont utilisées simultanément, les niveaux sont alors équivalents (“High Gain”).

BRIGHT SWITCH (Interrupteur “Bright”) (3)

Accentue (de +8 dB) les fréquences aiguës. Enfoncer l'interrupteur à la position “In” pour mettre en service.

PRE GAIN (4)

Côntrole le gain d'entrée du préamplificateur.

POST GAIN (5)

Commande le volume global de l'amplificateur. Le réglage final de niveau doit être effectué après avoir obtenu la sonorité désirée à l'aide des autres réglages.

LOW (Graves) (6)

Réglage de tonalité actif (type passe-bas, ± 15 dB), faisant varier l'atténuation ou l'accentuation des fréquences graves.

NOTE: Une accentuation excessive par égalisation (“EQ”), surtout dans les fréquences graves, augmente les risques de dommages aux haut-parleurs et diminue la réserve de puissance disponible.

GRAPHIC EQUALIZER (Égalisateur graphique) (7)

Cet égalisateur graphique à 7 bandes/une octave coupe ou renforce de 15dB à chaque fréquence centrale.

HIGH (Aiguës) (8)

Réglage de tonalité actif (type passe-haut, ± 15 dB) contrôlant l'atténuation ou l'amplification des fréquences aiguës.

CHORUS / EFFETS SEND (Envoi de chorus/effets) (9)

Prise de sortie équipée d'un filtre passe-haut permettant d'envoyer les fréquences supérieures à 200 Hz à un boîtier d'effets externes.

EFFECTS RETURN (Retour d'effets) (10)

Sert à brancher la sortie d'un appareil d'effets dans le mélangeur. Peut aussi servir comme entrée auxiliaire avec réglages indépendants.

PREAMP OUT / POWER AMP IN (Sortie préampli/entrée ampli) (11)

Ces prises jack de boucle d'effets permettent l'insertion d'un appareil d'effets. Pour relier un appareil d'effets, branchez la sortie du préampli (“Preamp Output”) à l'entrée de l'appareil. Branchez ensuite la sortie de l'appareil à l'entrée de l'ampli de puissance (“Power Amp Input”). Des câbles blindés de haute qualité doivent être utilisés pour ces connexions. La sortie “Preamp Output” peut aussi être utilisée pour amener le signal amplifié à une table de mixage, un magnétophone, ou autres. Branchez la sortie du préampli à l'entrée du magnétophone, mélangeur, etc, à l'aide de câbles blindés. Ce branchement n'affecte pas le fonctionnement de l'amplificateur.

NOTE: Le niveau de sortie du préampli est d'environ 1 volt sous impédance relativement basse (600 ohms). Les appareils d'effets insérés dans cette "boucle" doivent être capables de recevoir ce niveau d'entrée de 1 volt ainsi que de délivrer une sortie de 1 volt de façon à bien alimenter l'ampli de puissance. L'ampli de puissance possède un interrupteur interne qui débranche le préampli interne.

HEADPHONE JACK (Prise pour casque d'écoute) (12)

Ce jack stéréo envoie le signal aux deux cotés de tout casque d'écoute stéréo.

POWER LED (DEL témoin de mise sous tension) (13)

S'allume lorsque l'ampli reçoit l'alimentation CA.

POWER SWITCH (Interrupteur d'alimentation) (14)

Appuyez jusqu'en position "On" pour mettre sous tension.

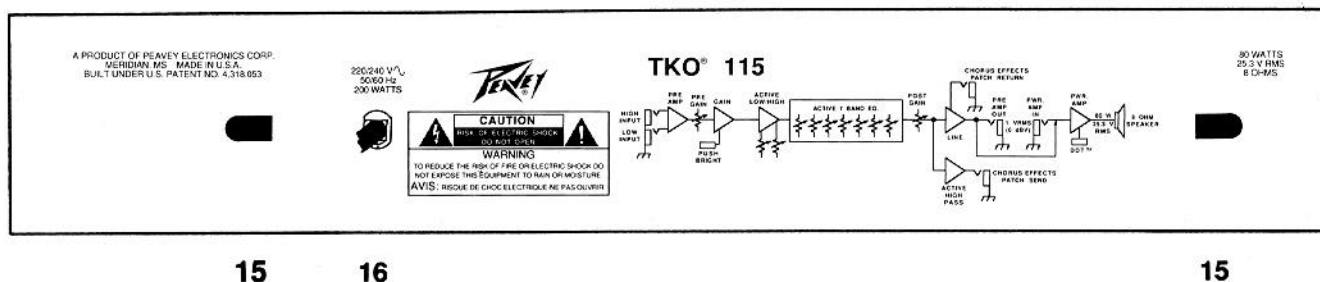

LINE (MAINS) CORD RETAINERS (Enrouleurs de câbles d'alimentation) (15)

Permet de remiser les câbles d'alimentation pour le transport.

GROUND SWITCH (Sélecteur de mise à terre) (16)

Commutateur rotatif à trois positions devant, la plupart du temps, être en position centrale (zéro). Dans certaines situations un bruit de ronflement ou un bourdonnement audible peut provenir des haut-parleurs de puissance. Dans ce cas, bougez le sélecteur de mise à terre jusqu'en position positive ou négative (+ ou -) ou jusqu'à ce que le bruit diminue.

NOTE: Si le problème de bruit persiste, consultez votre détaillant autorisé Peavey, la fabrique Peavey, ou un technicien de service qualifié. LE SÉLECTEUR DE MISE À TERRE NE FONCTIONNE PAS SUR LES APPAREILS 220/240 VOLT.

LINE CORD (120V products only)

(Cordon d'alimentation pour appareils 120V seulement) (17)

Pour votre sécurité, nous avons incorporé un câble d'alimentation secteur à 3 fils avec mise-à-terre appropriée. Il n'est pas recommandé d'enlever la broche de mise-à-terre en aucune circonstance. S'il est nécessaire d'utiliser l'équipement sans mise-à-terre appropriée, utilisez des adaptateurs de mise-à-terre convenables. Une bonne mise-à-terre amoindrit le bruit de fond et réduit grandement les risques de choc.

DEUTSCH

Siehe diagramm der frontplatte im englischen teil des handbuchs.

HIGH GAIN INPUT (High Gain-Eingang) (1)

Wird für die meisten elektrischen Bässe verwendet; ist 6 dB lauter als der Low Gain-Eingang.

LOW GAIN INPUT (2)

Dieser Eingang ist für die Instrumente vorgesehen, die ein besonders hohes Ausgangssignal erzeugen. Falls beide Eingänge gleichzeitig benutzt werden, sind die Ausgangssignale gleich (beide sind dann High Gain).

BRIGHT SWITCH (Bright-Schalter) (3)

Bewirkt eine voreingestellte Anhebung der hohen Frequenzen um 8 dB. Die Bright-Einstellung wird bei eingedrücktem Schalter ("In") aktiviert.

PRE GAIN (4)

Regelt die Eingangsempfindlichkeit des Vorverstärkers.

POST GAIN (5)

Kontrolliert die Gesamtlautstärke des Verstärkers. Die endgültige Lautstärke sollte erst eingestellt werden, wenn der gewünschte Sound erreicht ist.

LOW (6)

Eine aktive Klangregelung (± 15 dB) zur Anhebung oder Absenkung der tiefen Frequenzen.

OPERATION NOTE (Bedienungshinweis): Eine extreme Anhebung der Klangregelung insbesondere in den tiefen Frequenzen vergrößert die Gefahr von Lautsprecherschäden und beschneidet den verfügbaren Dynamikbereich (Headroom).

GRAPHIC EQUALIZER (Graphic Equalizer) (7)

Dieser Sieben-Band-Equalizer ermöglicht eine Anhebung oder Absenkung von 15 dB der Eckfrequenzen.

HIGH (8)

Eine aktive Klangregelung (± 15 dB) zur Anhebung oder Absenkung der hohen Frequenzen.

CHORUS/EFFECTS SEND (9)

Ausgang für Signale mit einer Frequenz, die höher ist als 200 Hz. Diese können dann zugemischt werden an externe Effektgeräte und Signal-Prozessoren.

EFFECTS RETURN (10)

Dieser Eingang ist dafür vorgesehen, das Ausgangssignal eines Effektgerätes zurück in den Mixer zu führen. Kann ebenfalls als unabhängiger variabler "Aux" seingang verwendet werden.

PREAMP OUT/POWER AMP IN (11)

Diese Buchsen sind vorgesehen für das direkte Einschleifen von Effektgeräten. Um ein Effektgerät anzuschließen, verbinden Sie den Preamp-Output mit dem Eingang des Effektgerätes. Als nächstes verbinden Sie den Ausgang des Effekts mit dem Power Amp-Input (für diese Anschlüsse müssen abgeschirmte Kabel verwendet werden). Der Preamp Output kann auch dazu benutzt werden, ein verstärktes Signal direkt in einen Mixer oder eine Bandmaschine zu leiten. Verbinden Sie den Preamp Output über ein abgeschirmtes Kabel mit dem Eingang des Mixers oder der Bandmaschine. Diese Verbindung hat keinen Einfluß auf die Funktion des Verstärkers. Anmerkung: Der Pre-amp Output Vorverstärkerausgangspegel beträgt c. 1 Volt RMS bei 600 Ohm. Jedes Effektgerät, das hier eingeschleift werden soll, muß ein Eingangs- und Ausgangssignal von 1 Volt haben, um den Poweramp richtig anzusteuern. Der Poweramp-Eingang hat einen internen Schalter, der den internen Preamp trennt.

HEADPHONE JACK (12)

Diese Stereo-Buchse erlaubt Signalfluß zu beiden Seiten eines jeden Stereo-Kopfhörers.

POWER LED (13)

Zeigt die eingeschaltete Netzspannung an.

POWER SWITCH (Netzschalter) (14)

Zum Einschalten in Position "On" drücken.

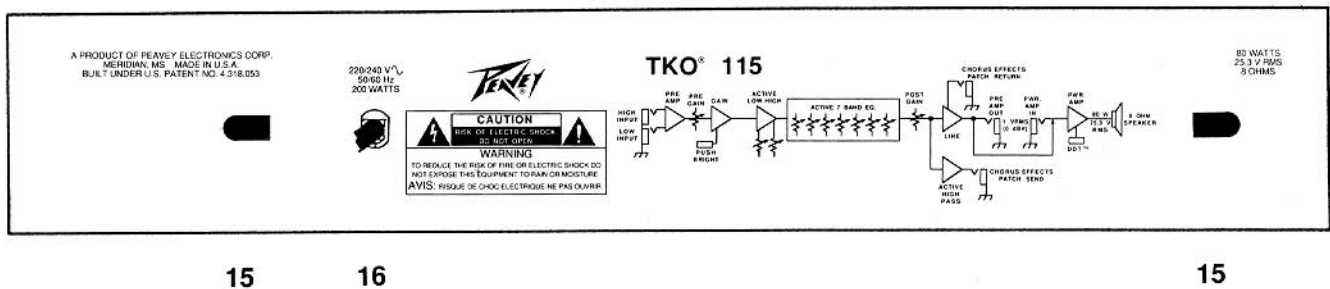

LINE (MAINS) CORD RETAINERS (15)

Befestigungsmöglichkeit für das Netzkabel.

GROUND SWITCH (16)

Der Ground-Schalter funktioniert nicht bei den 220/240 Volt-Modellen.

LINE CORD (120V products only) (Nur bei 120 Volt-Geräten) (17)

Zu Ihrer Sicherheit haben wir das Gerät mit einem dreiadrigen geerdeten Netzkabel versehen. Es ist unter keinen Umständen empfehlenswert den Erdungskontakt des Anschlußkabels zu lösen. Falls es notwendig sein sollte, das Equipment ohne die vorgesehene Erdung zu betreiben empfiehlt sich die Verwendung eines Grounding Adaptors. Die geringsten Störgeräusche und die höchste Sicherheit vor elektrischen Schlägen wird jedoch durch die Benutzung der vorgesehenen Erdungsmöglichkeiten erreicht.

THIS LIMITED WARRANTY VALID ONLY WHEN PURCHASED AND REGISTERED IN THE UNITED STATES OR CANADA. ALL EXPORTED PRODUCTS ARE SUBJECT TO WARRANTY AND SERVICES TO BE SPECIFIED AND PROVIDED BY THE AUTHORIZED DISTRIBUTOR FOR EACH COUNTRY.

Ces clauses de garantie ne sont valables qu'aux Etats-Unis et au Canada. Dans tous les autres pays, les clauses de garantie et de maintenance sont fixées par le distributeur national et assurées par lui selon la législation en vigueur.

Diese Garantie ist nur in den USA und Kanada gültig. Alle Export-Produkte sind der Garantie und dem Service des Importeurs des jeweiligen Landes unterworfen. Esta garantía es válida solamente cuando el producto es comprado en E.U. continentales o en Canada. Todos los productos que sean comprados en el extranjero, están sujetos a las garantías y servicio que cada distribuidor autorizado determine y ofrezca en los diferentes países.

**PEAVEY ONE-YEAR LIMITED
WARRANTY/REMEDY**

PEAVEY ELECTRONICS CORPORATION ("PEAVEY") warrants this product, EXCEPT for covers, footswitches, patchcords, tubes and meters, to be free from defects in material and workmanship for a period of one (1) year from date of purchase, PROVIDED, however, that this limited warranty is extended only to the original retail purchaser and is subject to the conditions, exclusions, and limitations hereinafter set forth:

PEAVEY 90-DAY LIMITED WARRANTY ON TUBES AND METERS

If this product contains tubes or meters, Peavey warrants the tubes or meters contained in the product to be free from defects in material and workmanship for a period of ninety (90) days from date of purchase; PROVIDED, however, that this limited warranty is extended only to the original retail purchaser and is also subject to the conditions, exclusions, and limitations hereinafter set forth.

CONDITIONS, EXCLUSIONS, AND LIMITATIONS OF LIMITED WARRANTIES

These limited warranties shall be void and of no effect, if:

- a. The first purchase of the product is for the purpose of resale; or
- b. The original retail purchase is not made from an AUTHORIZED PEAVEY DEALER; or
- c. The product has been damaged by accident or unreasonable use, neglect, improper service or maintenance, or other causes not arising out of defects in material or workmanship; or
- d. The serial number affixed to the product is altered, defaced, or removed.

In the event of a defect in material and/or workmanship covered by this limited warranty, Peavey will:

- a. In the case of tubes or meters, replace the defective component without charge.
- b. In other covered cases (i.e., cases involving anything other than covers, footswitches, patchcords, tubes or meters), repair the defect in material or workmanship or replace the product, at Peavey's option; and provided, however, that, in any case, all costs of shipping, if necessary, are paid by you, the purchaser.

THE WARRANTY REGISTRATION CARD SHOULD BE ACCURATELY COMPLETED AND MAILED TO AND RECEIVED BY PEAVEY WITHIN FOURTEEN (14) DAYS FROM THE DATE OF YOUR PURCHASE.

In order to obtain service under these warranties, you must:

- a. Bring the defective item to any PEAVEY AUTHORIZED DEALER or AUTHORIZED PEAVEY SERVICE CENTER and present therewith the ORIGINAL PROOF OF PURCHASE supplied to you by the AUTHORIZED PEAVEY DEALER in connection with your purchase from him of this product.
If the DEALER or SERVICE CENTER is unable to provide the necessary warranty service you will be directed to the nearest other PEAVEY AUTHORIZED DEALER or AUTHORIZED PEAVEY SERVICE CENTER which can provide such service.

OR

- b. Ship the defective item, prepaid, to:

PEAVEY ELECTRONICS CORPORATION
International Service Center
Highway 80 East
MERIDIAN, MS 39301

including therewith a complete, detailed description of the problem, together with a legible copy of the original PROOF OF PURCHASE and a complete return address. Upon Peavey's receipt of these items:

If the defect is remedial under these limited warranties and the other terms and conditions expressed herein have been complied with, Peavey will provide the necessary warranty service to repair or replace the product and will return it, FREIGHT COLLECT, to you, the purchaser.

Peavey's liability to the purchaser for damages from any cause whatsoever and regardless of the form of action, including negligence, is limited to the actual damages up to the greater of \$500.00 or an amount equal to the purchase price of the product that caused the damage or that is the subject of or is directly related to the cause of action. Such purchase price will be that in effect for the specific product when the cause of action arose. This limitation of liability will not apply to claims for personal injury or damage to real property or tangible personal property allegedly caused by Peavey's negligence. Peavey does not assume liability for personal injury or property damage arising out of or caused by a non-Peavey alteration or attachment, nor does Peavey assume any responsibility for damage to interconnected non-Peavey equipment that may result from the normal functioning and maintenance of the Peavey equipment.

UNDER NO CIRCUMSTANCES WILL PEAVEY BE LIABLE FOR ANY LOST PROFITS, LOST SAVINGS, ANY INCIDENTAL DAMAGES, OR ANY CONSEQUENTIAL DAMAGES ARISING OUT OF THE USE OR INABILITY TO USE THE PRODUCT, EVEN IF PEAVEY HAS BEEN ADVISED OF THE POSSIBILITY OF SUCH DAMAGES.

THESE LIMITED WARRANTIES ARE IN LIEU OF ANY AND ALL WARRANTIES, EXPRESSED OR IMPLIED, INCLUDING, BUT NOT LIMITED TO, THE IMPLIED WARRANTIES OF MERCHANTABILITY AND FITNESS FOR A PARTICULAR USE; PROVIDED, HOWEVER, THAT IF THE OTHER TERMS AND CONDITIONS NECESSARY TO THE EXISTENCE OF THE EXPRESSED, LIMITED WARRANTIES, AS HEREINABOVE STATED, HAVE BEEN COMPLIED WITH, IMPLIED WARRANTIES ARE NOT DISCLAIMED DURING THE APPLICABLE ONE-YEAR OR NINETY-DAY PERIOD FROM DATE OF PURCHASE OF THIS PRODUCT.

SOME STATES DO NOT ALLOW LIMITATION ON HOW LONG AN IMPLIED WARRANTY LASTS, OR THE EXCLUSION OR LIMITATION OF INCIDENTAL OR CONSEQUENTIAL DAMAGES, SO THE ABOVE LIMITATIONS OR EXCLUSIONS MAY NOT APPLY TO YOU. THESE LIMITED WARRANTIES GIVE YOU SPECIFIC LEGAL RIGHTS, AND YOU MAY ALSO HAVE OTHER RIGHTS WHICH MAY VARY FROM STATE TO STATE.

THESE LIMITED WARRANTIES ARE THE ONLY EXPRESSED WARRANTIES ON THIS PRODUCT, AND NO OTHER STATEMENT, REPRESENTATION, WARRANTY, OR AGREEMENT BY ANY PERSON SHALL BE VALID OR BINDING UPON PEAVEY.

In the event of any modification or disclaimer of expressed or implied warranties, or any limitation of remedies, contained herein conflicts with applicable law, then such modification, disclaimer or limitation, as the case may be, shall be deemed to be modified to the extent necessary to comply with such law.

Your remedies for breach of these warranties are limited to those remedies provided herein and Peavey Electronics Corporation gives this limited warranty only with respect to equipment purchased in the United States of America.

INSTRUCTIONS — WARRANTY REGISTRATION CARD

1. Mail the completed WARRANTY REGISTRATION CARD to:

PEAVEY ELECTRONICS CORPORATION
POST OFFICE BOX 2898
MERIDIAN, MISSISSIPPI 39302-2898

- a. Keep the PROOF OF PURCHASE. In the event warranty service is required during the warranty period, you will need this document. **There will be no identification card issued by Peavey Electronics Corporation.**
2. IMPORTANCE OF WARRANTY REGISTRATION CARDS AND NOTIFICATION OF CHANGES OF ADDRESSES:
 - a. Completion and mailing of WARRANTY REGISTRATION CARDS — Should notification become necessary for any condition that may require correction, the REGISTRATION CARD will help ensure that you are contacted and properly notified.
 - b. Notice of address changes — If you move from the address shown on the WARRANTY REGISTRATION CARD, you should notify Peavey of the change of address so as to facilitate your receipt of any bulletins or other forms of notification which may become necessary in connection with any condition that may require dissemination of information or correction.
3. You may contact Peavey directly by telephoning (601) 483-5365.

IMPORTANT SAFETY INSTRUCTIONS

WARNING When using electric products, basic cautions should always be followed, including the following.

1. Read all safety and operating instructions before using this product.
2. All safety and operating instructions should be retained for future reference.
3. Obey all cautions in the operating instructions and on the back of the unit.
4. All operating instructions should be followed.
5. This product should not be used near water, i.e., a bathtub, sink, swimming pool, wet basement, etc.
6. This product should be located so that its position does not interfere with its proper ventilation. It should not be placed flat against a wall or placed in a built-in enclosure that will impede the flow of cooling air.
7. This product should not be placed near a source of heat such as a stove, radiator, or another heat producing amplifier.
8. Connect only to a power supply of the type marked on the unit adjacent to the power supply cord.
9. Never break off the ground pin on the power supply cord. For more information on grounding, write for our free booklet "Shock Hazard and Grounding."
10. Power supply cords should always be handled carefully. Never walk or place equipment on power supply cords. Periodically check cords for cuts or signs of stress, especially at the plug and the point where the cord exits the unit.
11. The power supply cord should be unplugged when the unit is to be unused for long periods of time.
12. If this product is to be mounted in an equipment rack, rear support should be provided.
13. Metal parts can be cleaned with a damp rag. The vinyl covering used on some units can be cleaned with a damp rag, or an ammonia-based household cleaner if necessary. Disconnect unit from power supply before cleaning.
14. Care should be taken so that objects do not fall and liquids are not spilled into the unit through the ventilation holes or any other openings.
15. This unit should be checked by a qualified service technician if
 - a. The power supply cord or plug has been damaged.
 - b. Anything has fallen or been spilled into the unit.
 - c. The unit does not operate correctly.
 - d. The unit has been dropped or the enclosure damaged.
16. The user should not attempt to service this equipment. All service work should be done by a qualified service technician.
17. This product should be used only with a cart or stand that is recommended by Peavey Electronics.
18. Exposure to extremely high noise levels may cause a permanent hearing loss. Individuals vary considerably in susceptibility to noise induced hearing loss, but nearly everyone will lose some hearing if exposed to sufficiently intense noise for a sufficient time.

The U.S. Government's Occupational Safety and Health Administration (OSHA) has specified the following permissible noise level exposures

Duration Per Day In Hours	Sound Level dBA, Slow Response
8	90
6	92
4	95
3	97
2	100
1½	102
1	105
½	110
¼ or less	115

According to OSHA, any exposure in excess of the above permissible limits could result in some hearing loss.

Ear plugs or protectors in the ear canals or over the ears must be worn when operating this amplification system in order to prevent a permanent hearing loss if exposure is in excess of the limits as set forth above. To ensure against potentially dangerous exposure to high sound pressure levels, it is recommended that all persons exposed to equipment capable of producing high sound pressure levels such as this amplification system be protected by hearing protectors while this unit is in operation.

SAVE THESE INSTRUCTIONS



Features and specifications subject to change without notice.

Peavey Electronics Corporation 711 A Street / Meridian, MS 39302-2898 / U.S.A. / (601)483-5365 / Telex 504115 / Fax 486-1278

©1993

#80301902

Printed in U.S.A. 9/93